

Zubehör für Brenner und Zündbrenner

Accessories for burners and igniters

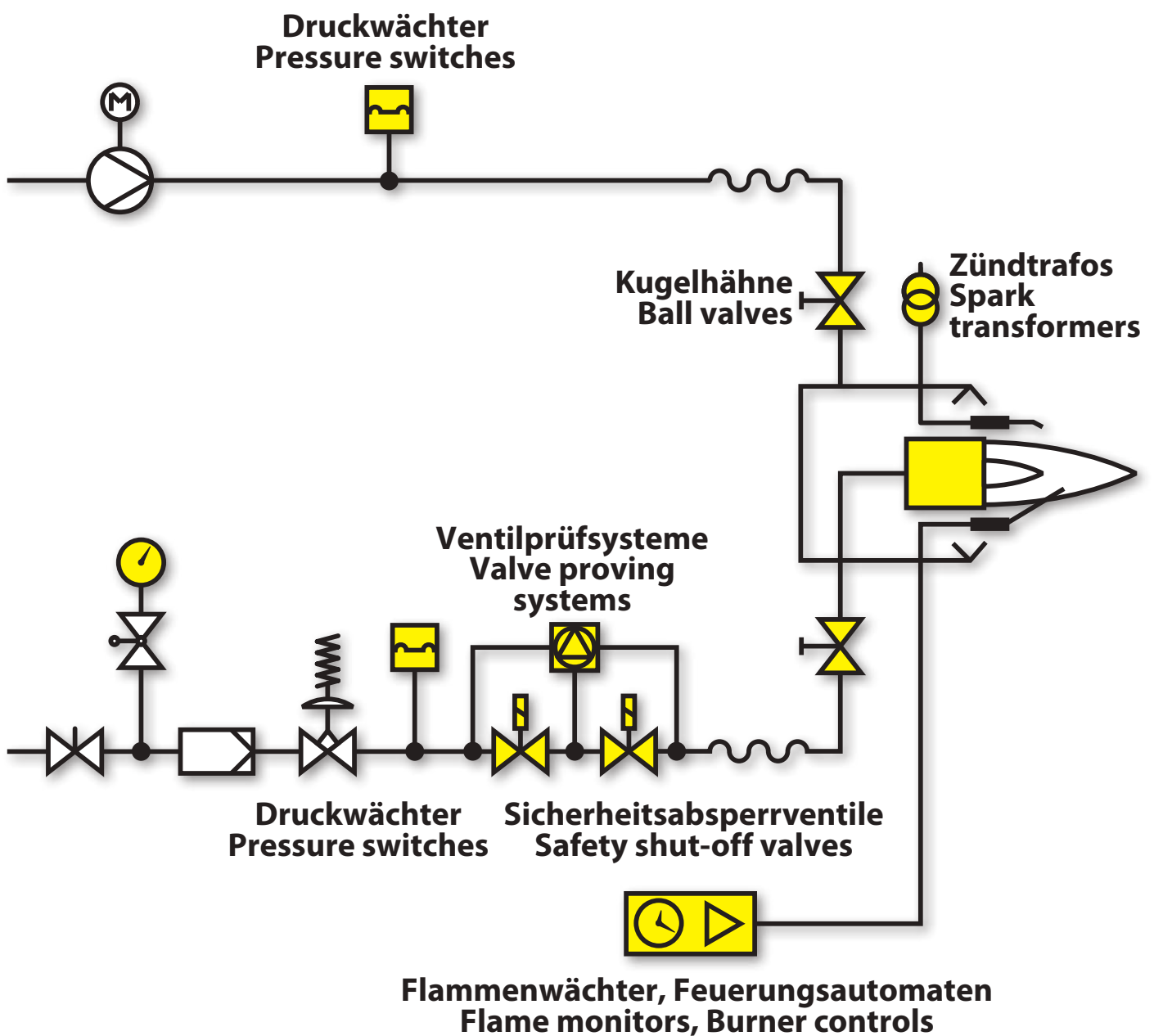

Zusammenschaltung von Brennern und Zündbrennern mit Zündtrafos und Steuergeräten
Connecting burners and igniters to spark transformers and control devices

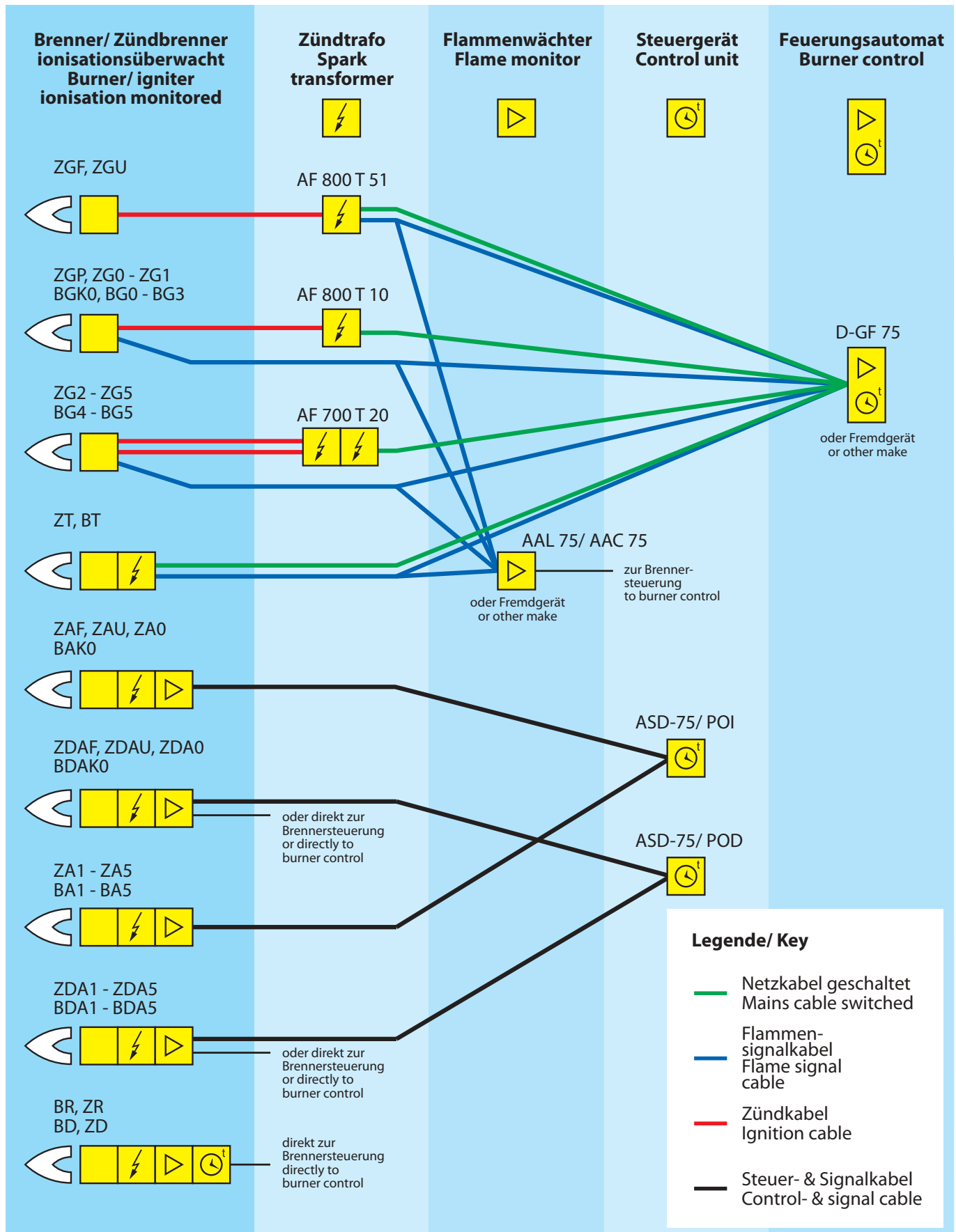

Ionisations-Flammenwächter
Ionisation flame monitor
AAL 75



©DURAG GROUP

Betrieb	für intermittierenden Betrieb oder Dauerbetrieb, mit 1 potentialfreien Wechselkontakt
Betriebsspannung	115/ 125/ 230/ 250 VAC 50/ 60 Hz
Leistung	10 VA
Schutzart Gehäuse	IP40
Schutzart Klemmleiste	IP20
Flammensignalausgang	zwei potenzialfreie Schaltkontakte: max. 315 mA/ 250 VAC und max. 2 A/ 250 VAC
Signalkabellänge	max. 150 m
Gehäuse	Kunststoff
Einbau	in Schaltschrank auf 35 mm Hutprofilschiene nach IEC/ EN 60715
Geeignet für	Zünder und Brenner mit Ionisationselektrode/ Zünder und Brenner mit Zündtransformator und Ionisations-Flammenwächter (Hegweil)
Gewicht	ca. 550 g
Zul. Umgebungstemperatur	-20 °C bis +60 °C
FFDT (Sicherheitszeit)	≤ 1 s

operation	for intermittent or continuous operation, with 1 volt-free relay contact
supply voltage	115/ 125/ 230/ 250 VAC 50/ 60 Hz
power rating	10 VA
protection rating enclosure	IP40
protection rating terminal strip	IP20
flame signal output	two SPT contacts: max. 315 mA/ 250 VAC and max. 2 A/ 250 VAC
signal cable length	max. 150 m
housing	plastic
mounting	in control cabinet on 35 mm rails according to IEC/ EN 60715
suitable for	igniters and burners with flame rod/ igniters and burners with spark transformer and ionisation flame monitor (Hegweil)
weight	approx. 550 g
perm. ambient temperature	-20 °C to +60 °C
FFDT (safety time)	≤ 1 s

Ionisations-Flammenwächter mit Flammensignalwandler
4...20 mA
Ionisation flame monitor with flame signal converter
4...20 mA
AAC 75

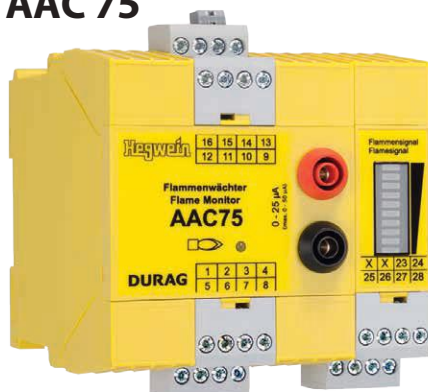

©DURAG GROUP

Ausführungen	AAC 75 POD/... für intermittierenden Betrieb und Dauerbetrieb AAC 75 POD/...G... Sonderausführung mit Goldkontakten
Betriebsspannung	230 V (-15 %/ +10 % bei 50/ 60 Hz) oder Sonderspannungen: 115 V/ 125 V/ 250 V
Leistung	10 VA
Umgebungstemperatur	-20 °C bis +60 °C
FFDT (Sicherheitszeit)	≤ 1 s
Anzeige	LED/ Bargraph (optional)
Schutzart Gehäuse	IP40
Schutzart Klemmleiste	IP20
Flammensignalausgang	zwei potentialfreie Schaltkontakte: max. 315 mA/ 250 VAC und max. 2 A/ 250 VAC
Signalkabellänge	max. 150 m
Gehäuse	Kunststoff
Einbau	in Schaltschrank auf 35 mm Hutprofilschiene nach IEC/ DIN 60715
Geeignet für	Zünder und Brenner mit Ionisationselektrode/ Zünder und Brenner mit Zündtransformator und Ionisations-Flammenwächter (Hegweil)
Gewicht	ca. 650 g
Flammensignalwandler	
Bürde	max. 120 Ohm (Ausgangssignal 4–20 mA)
Max. Ausgangssignal	21 mA

models	AAC 75 POD/... for intermittent and continuous operation AAC 75 POD/...G... special version with gold plated contacts
supply voltage	230 V (-15 %/ +10 % at 50/ 60 Hz) or special voltages: 115 V/ 125 V/ 250 V
power rating	10 VA
ambient temperature	-20 °C to +60 °C
FFDT (safety time)	≤ 1 s
display	LED/ Bargraph (optional)
protection rating enclosure	IP40
protection rating terminal strip	IP20
flame signal output	two SPDT contacts: max. 315 mA/ 250 VAC and max. 2 A/ 250 VAC
signal cable length	max 150 m
housing	plastic
mounting	in control cabinet on 35 mm rails according to IEC/ EN 60715
suitable for	igniters and burners with flame rod/ igniters and burners with spark transformer and ionisation flame monitor (Hegweil)
weight	approx. 650 g
flame signal converter	
apparent ohmic load	120 ohm maximum (output signal 4-20 mA)
maximum output signal	21 mA

Flammenrelais Flame relay A 285 K 2.3



©DURAG GROUP

Betrieb	zur Einbindung in eine übergeordnete Brennersteuerung
Betriebsspannung	90 - 110 VDC
Schutzart	IP20
Signalkabellänge	max. 150 m
Einbau	in Schaltschrank auf 35 mm Hutprofilschiene nach IEC/EN 60715
Geeignet für	Zünder und Brenner mit Zündtrafo und Ionisations-Flammenwächter (Hegweil)
Kontakte	2 potentialfreie Wechselkontakte, max. 250 VAC, 1 A ohmsche Last
Gewicht	ca. 170 g
Zul. Umgebungstemperatur	-20 °C bis +60 °C

operation	for integration into the main burner management system
supply voltage	90 - 110 VDC
protection	IP20
signal cable length	max. 150 m
mounting	in control cabinet on 35 mm rails according to IEC/EN 60715
suitable for	igniters and burners with spark transformer and ionisation flame monitor (Hegweil)
contacts	2 volt-free change-over, max. 250 VAC, 1 A resistive load
weight	approx. 170 g
perm. ambient temperature	-20 °C to +60 °C

Feuerungsautomat Burner control ASD-75/ POI



©DURAG GROUP

Betriebsart	Intermittierender Betrieb
Netzspannung	115/ 230 VAC, 50/ 60 Hz
Vorlüftzeit	0 s, 30 s, 60 s oder 120 s
Erste Sicherheitszeit (Anlauf)	3 s, 5 s, 10 s oder 15 s
FFRT (Flammenausfallzeit)	1 s, 2 s, 3 s oder 5 s
Flammenintensität	0...50 µA
Zul. Umgebungstemperatur	-20 °C bis +60 °C
Installation	Hutschiene TS 35
Schutzart	IP20
Anzeige	LED
Gewicht	ca. 1 kg
Eingänge	externer Flammenwächter, 90-110 VDC Flammensignal
Länge Flammensignalkabel	max. 150 m
Abmessungen	113x103x118 mm (BxHxT)

operational mode	intermittent operation
power supply	115/ 230 VAC, 50/ 60 Hz
prepurge time	0 s, 30 s, 60 s or 120 s
first safety time (start-up)	3 s, 5 s, 10 s or 15 s
FFRT (flame failure response time)	1 s, 2 s, 3 s or 5 s
flame intensity	0...50 µA
perm. ambient temperature	-20 °C to +60 °C
installation	DIN-rail TS 35
protection	IP20
display	LED
weight	approx. 1 kg
inputs	external flame monitor, 90-110 VDC flame signal
length of flame signal cable	max. 150 m
dimensions	113x103x118 mm (wxhxd)

Feuerungsautomat Burner control ASD-75/ POD

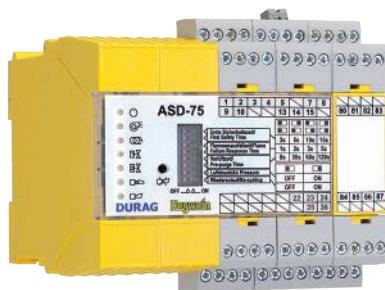

©DURAG GROUP

Betriebsart	Dauerbetrieb
Netzspannung	115/ 230 VAC, 50/ 60 Hz
Vorlüftzeit	0 s, 30 s, 60 s oder 120 s
Erste Sicherheitszeit (Anlauf)	3 s, 5 s, 10 s oder 15 s
FFRT (Flammenausfallzeit)	1 s, 2 s, 3 s oder 5 s
Flammenintensität	0...50 µA
Zul. Umgebungstemperatur	-20 °C bis +60 °C
Installation	Hutschiene TS 35
Schutzart	IP20
Anzeige	LED
Gewicht	ca. 1 kg
Eingänge	externer Flammenwächter, 90-110 VDC Flammensignal
Länge Flammensignalkabel	max. 150 m
Abmessungen	113x103x118 mm (BxHxT)

operational mode	continuous operation
power supply	115/ 230 VAC, 50/ 60 Hz
prepurge time	0 s, 30 s, 60 s or 120 s
first safety time (start-up)	3 s, 5 s, 10 s or 15 s
FFRT (flame failure response time)	1 s, 2 s, 3 s or 5 s
flame intensity	0...50 µA
perm. ambient temperature	-20 °C to +60 °C
installation	DIN-rail TS 35
protection	IP20
display	LED
weight	approx. 1 kg
inputs	external flame monitor, 90-110 VDC flame signal
length of flame signal cable	max. 150 m
dimensions	113x103x118 mm (wxhxd)

**Feuerungsautomat
Burner control
D-GF 75**

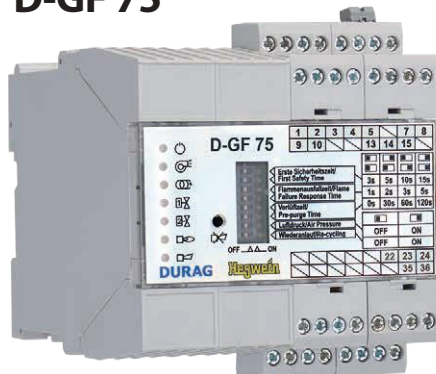

©DURAG GROUP

Betriebsart	D-GF 75-10: Intermittierender Betrieb, D-GF 75-20: Dauerbetrieb
Netzspannung	115/ 230 VAC, 50/ 60 Hz
Vorlüftzeit	0 s, 30 s, 60 s oder 120 s
Erste Sicherheitszeit (Anlauf)	3 s, 5 s, 10 s oder 15 s
FFRT (Flammenausfallzeit)	1 s, 2 s, 3 s oder 5 s
Flammenintensität	0...50 µA
Zul. Umgebungstemperatur	-20 °C bis +60 °C
Installation	Hutschiene TS 35
Schutzart	IP20
Anzeige	LED
Gewicht	ca. 1 kg
Flammenfühler	externer Flammenwächter, Ionisationselektrode
Länge der Ionisationsleitung	max. 150 m (abgeschirmtes Kabel)
Abmessungen	91x103x118 mm (BxHxT)

operational mode	D-GF 75-10: intermittent operation D-GF 75-20: continuous operation
power supply	115/ 230 VAC, 50/ 60 Hz
prepurge time	0 s, 30 s, 60 s or 120 s
first safety time (start-up)	3 s, 5 s, 10 s or 15 s
FFRT (flame failure response time)	1 s, 2 s, 3 s or 5 s
flame intensity	0...50 µA
perm. ambient temperature	-20 °C to +60 °C
installation	DIN-rail TS 35
protection	IP20
display	LED
weight	approx. 1 kg
flame sensor	external flame monitor, ionisation electrode
length of ionisation cable	max. 150 m (shielded cable)
dimensions	91x103x118 mm (wxhxd)

**Zündtrafos
Spark transformer
AF**



©DURAG GROUP

	AF 700 T 20	AF 800 T 10	AF 800 T 51	AF 900 T 10
Zündung ignition	Elektrode gegen Masse electrode against ground			
Betriebsspannung supply voltage	standard: 220/ 230 VAC, 50/ 60 Hz optional: 110/ 120 VAC, 50/ 60 Hz			
Gewicht weight	4 kg	1,9 kg	1,9 kg	3,5 kg
Zul. Umgebungstemperatur perm. ambient temperature	-20 °C bis +60 °C für alle Varianten -20 °C to +60 °C for all variants			
Leistung power rating	2x100 VA	100 VA	100 VA	100 VA
Zündung ignition	2x5 kV	5 kV	5 kV	5 kV
Einschaltdauer duty cycle	15 %	15 %	15 %	100 %
Schutzart protection	IP65	IP65	IP65	IP65
Maße L x B x H dimensions l x d x h	156x156x95 mm	122x122x94 mm	122x122x94 mm	156x156x95 mm
Gehäuse housing	GAI cast aluminum	GAI cast aluminum	GAI cast aluminum	GAI cast aluminum
Bemerkungen remarks	Zündung: Elektrode gegen Elektrode möglich Ignition: electrode against electrode possible		für 1-Elektroden- zündler for igniters with combined spark/ flame rod	

**Druckwächter
Pressure switch
FD**



©DURAG GROUP

Betrieb	für Gase nach G 260 und Luft
Druckanschluss	Rp 1/4
Zul. Umgebungstemperatur	0 °C bis +60 °C
Gewicht	750 g
Schutzart	IP54
Max. Betriebsdruck	FD...K0: 50 mbar, FD...K1 - 7: 300 mbar
Typ	Eigenschaften
FD 2 K 0	Grundtyp, Einstellbereich 2-10 mbar
FD 6 K 0	mit roter Signallampe
FD 8 K 0	mit grüner Signallampe
FD 2 K 1-7	Grundtyp, Einstellbereich 5-70 mbar
FD 6 K 1-7	mit roter Signallampe
FD 8 K 1-7	mit grüner Signallampe

operation	for gases according to DVGW-data sheet G 260 and air
gas port	Rp 1/4
perm. ambient temperature	0 °C to +60 °C
weight	750 g
protection	IP54
max. operating pressure	FD...K0: 50 mbar, FD...K1 - 7: 300 mbar
type	features
FD 2 K 0	basic type, setting range 2-10 mbar
FD 6 K 0	with red indicator lamp
FD 8 K 0	with green indicator lamp
FD 2 K 1-7	basic type, setting range 5-70 mbar
FD 6 K 1-7	with red indicator lamp
FD 8 K 1-7	with green indicator lamp

Ventilprüfsysteme
Valve proving systems
AD

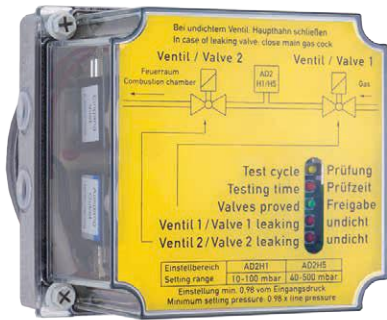

©DURAG GROUP

für Gase nach G 260

Anwendung

Vor jedem Brennerstart oder nach jeder Brennerabschaltung wird eine Überprüfung von 2 Gas-Sicherheitsabsperrentilen auf Dichtheit durchgeführt.

for gases according to DVGW-data sheet G 260

Application

Two gas safety shut-off valves are checked for their tightness prior to every burner start-up or after every shut-down.

Lieferbare Typen available versions	AD 2 H 1	AD 2 H 5
Betriebsdruck max. operating pressure	100 mbar 100 mbarg	500 mbar 500 mbarg
Betriebsspannung supply voltage	standard: 115 VAC, 230 VAC optional: 24 VDC	standard: 115 VAC, 230 VAC optional: 24 VDC
Temperatur temperature	0 °C bis +60 °C 0 °C to +60 °C	0 °C bis +60 °C 0 °C to +60 °C
Schutzart protection	IP54	IP54
Einstellbereich setting range	10 – 100 mbar 10 – 100 mbarg	40 – 500 mbar 40 – 500 mbarg
Prüfzeit testing time	1 – 130 s	1 – 130 s
Zul. Umgebungstemperatur perm. ambient temperature	-10 °C bis +60 °C -10 °C to +60 °C	-10 °C bis +60 °C -10 °C to +60 °C
Gasanschluss gas port	Rp 1/4	Rp 1/4

Manometer
Pressure gauge
S2610



©DURAG GROUP

Digital anzeigendes Messgerät

Batteriebetriebenes, handliches Messgerät mit elektronischem Sensor für Druck und Differenzdruck. Unempfindlich gegen Staub und Feuchtigkeit. Besonders geeignet für die Inbetriebnahme und Wartung von Brennern und Zündbrennern sowie zur Differenzdruckmessung an Luftfiltern

Measuring device with digital readout

Battery operated, handy unit with electronic sensor for pressure and differential pressure. Impervious to dust and moisture. Ideally suited for the commissioning and maintenance of burners and igniters and to pick up the pressure loss of air filters

Bedienung	Folientastatur
Nullpunkt	einstellbar
Messbereich	0 – 1000 mbar
Überdrucksicherheit	bis 3 bar

handling	foil covered keyboard
zero-adjustment	manually
range	0 – 1000 mbarg
pressure resistance	max. 3 barg

µ-Amperemeter
µ-Ammeter
MA 0-50



©DURAG GROUP

Anwendung	Gleichstrom-Amperemeter zur Messung des Flammensignals
Messbereich	0 - 50 µA
Sicherung	32 mA (F)
Kabellänge	1 m
Kabelanschluss	Labor-Messleitung
Kabelquerschnitt	1 mm ²
Steckverbindergröße	4 mm

application	DC-ammeter to measure the flame signal
measuring range	0 - 50 µA
fuse	32 mA (quick-blowing)
cable length	1 m
cable connection	laboratory plug
wire gauge	1 mm ²
plug size	4 mm

Kugelhähne
Ball valves
Z 845 Z



©DURAG GROUP

Anwendung	Zur Einstellung des Gas-Volumenstroms bei Brennern und Zündbrennern Nur mit Werkzeug verstellbar
Gehäuse	MS 58
Anschluss	Innen-/ Außengewinde
Typ	Anschluss
Z 845 Z 1	1/4"
Z 845 Z 2	3/8"
Z 845 Z 3	1/2"
Z 845 Z 4	3/4"
Z 845 Z 5	1"

application	to adjust the gas flow of burners and igniters tool required for adjustment
body	brass
connection threads	male/ female
type	connection
Z 845 Z 1	1/4"
Z 845 Z 2	3/8"
Z 845 Z 3	1/2"
Z 845 Z 4	3/4"
Z 845 Z 5	1"

Luftreguliermuffen
Air regulating sleeves
Z 945 Z



©DURAG GROUP

Anwendung	Zur Einstellung des Luft-Volumenstroms bei Brennern und Zündbrennern, nur mit Werkzeug verstellbar Einstellkegel arretierbar, nur mit Werkzeug verstellbar
Gehäuse	Temperguss verzinkt
Anschluss	beidseitig Innengewinde
Typ	Anschluss
Z 945 Z 1	Rp 3/4
Z 945 Z 2	Rp 1
Z 945 Z 3	Rp 1 1/2
Z 945 Z 6	Rp 2
Zubehör	T1K1 Reguliermuffenschlüssel

application	to adjust the air flow of burners and igniters tool required for adjustment adjustment cone can be locked
body	malleable cast iron, galvanized
connection threads	female/ female
type	connection
Z 945 Z 1	Rp 3/4
Z 945 Z 2	Rp 1
Z 945 Z 3	Rp 1 1/2
Z 945 Z 6	Rp 2
accessories	T1K1 regulating sleeve key

Doppelnippel
Double nipple
Z 946 F

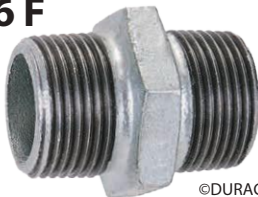

©DURAG GROUP

Anwendung	Für den direkten Anbau der Luftreguliermuffe an den Brennern und Zündbrennern
Gehäuse	Temperguss verzinkt
Typ	Anschluss
Z 946 F 2	R 3/4
Z 946 F 3	R 1
Z 946 F 4	R 1 1/2
Z 946 F 10	R 2

application	to mount the air regulating sleeve to the burner or igniter
body	malleable cast iron, galvanized
type	connection
Z 946 F 2	R 3/4
Z 946 F 3	R 1
Z 946 F 4	R 1 1/2
Z 946 F 10	R 2

DURAG

DURAG GmbH
Kollaustraße 105
22453 Hamburg, Germany
Tel. +49 40 55 42 18-0
Fax +49 40 58 41 54
E-Mail: info@durag.de



**A Brand of
DURAG GmbH**



**A Brand of
DURAG GmbH**



DURAG data systems GmbH
Kollaustraße 105
22453 Hamburg, Germany
Tel. +49 40 55 42 18-3000
Fax +49 40 55 42 18-3099
E-Mail: info@durag-data.de



**A Brand of
DURAG data systems GmbH
Branch Office Austria**
Lastenstraße 36, City Tower 2
4020 Linz, Austria
Tel. +43 732 60 99 60-0
Fax +43 732 60 99 60-4
E-Mail: office@utas.at



DURAG Siena do Brasil Ltda
Rua Vinte e Dois de Agosto, 66
Diadema - SP
09941-530 Brazil
Tel. +55 11 4071-5050 r.28
Fax +55 11 4077-1718
E-Mail: info@duragsiena.com.br



Hegwein GmbH
Am Boschwerk 7
70469 Stuttgart
Germany
Tel. +49 711 135 788-0
Fax +49 711 135 788-5
E-Mail: info@hegwein.de



SMITSVONK Holland B.V.
P.O. Box 180, 2700 AD Zoetermeer
Goudstraat 6, 2718 RC Zoetermeer
Netherlands
Tel. +31 79 361 35 33
Fax +31 79 361 13 78
E-Mail: sales@smitsvonk.nl



**GRIMM Aerosol Technik
GmbH & Co. KG**
Dorfstraße 9
83404 Ainring, Germany
Tel. +49 8654 578-0
Fax +49 8654 578-35
E-Mail: info@grimm-aerosol.com

DURAG GROUP SALES

**DURAG Sales and Marketing
GmbH & Co. KG**
Kollaustraße 105
22453 Hamburg, Germany
Tel. +49 40 55 42 18-0
Fax +49 40 58 41 54
E-Mail: info@durag.de

DURAG Brazil
DURAG Siena do Brasil Ltda
Rua Vinte e Dois de Agosto, 66
Diadema - SP
09941-530 Brazil
Tel. +55 11 4071-5050 r.28
Fax +55 11 4077-1718
E-Mail: info@duragsiena.com.br

DURAG France S.a.r.l.
Parc GIP Charles de Gaulle
49, rue Léonard de Vinci, BP 70166
95691 Goussainville CEDEX
France
Tel. +33 1 301 811 80
Fax +33 1 393 383 60
E-Mail: info@durag-france.fr

DURAG, Inc., USA
1355 Mendota Heights Road
Suite 200
Mendota Heights
MN 55120, USA
Tel. +1 651 451-1710
Fax +1 651 457-7684
E-Mail: durag@durag.com

**DURAG India Instrumentation
Private Limited**
#27/30, 2nd Main Road
Industrial Town, Rajajinagar
Bengaluru 560 044, India
Tel. +91 80 2314 5626, 2301 1700
Fax +91 80 2314 5627
E-Mail: info@duragindia.com

**DURAG Instrumentation
(Shanghai) Co., Ltd.**
Room 706, Dibao Plaza, No. 3998
Hongxin Rd., Minhang District
Shanghai, 201103 PR China
Tel. +86 21 60732979-200
Fax +86 21 60732980-205
E-Mail: info@durag-cn.com

DURAG Italia S.r.l.
Via Carlo Panseri, 118
CIM uffici, P. secondo
28100 Novara
Italy
Tel. +39 0321 679569
Fax +39 0321 474165
E-Mail: info@durag.it

DURAG Japan Office
c/o TMS Planning Inc.
291-2 Umena, Mishima-shi
Shizuoka-ken
411-0816 Japan
Tel. +81 55 977 3994
Fax +81 55 977 3994
E-Mail: info@durag.jp

DURAG Korea Office
RM #1131, Manhattan Building
36-2, Yeouido-Dong
Yeongdeungpo-Gu, Seoul
Korea
Tel. +82 2 761 8970
Fax +82 2 761 8971
E-Mail: info@durag-group.co.kr

DURAG Middle East (Branch)
Dubai Airport Free Zone
5 West Wing, Office 124
Dubai, UAE
P.O. Box 371555
Tel. +971 4260251 0
E-Mail: dme@durag.de

DURAG RUSS OOO
Andropova avenue 18/6
Office 5-09
115432 Moscow
Russia
Tel. +7 499 4180090
Fax +7 499 4180091
E-Mail: info@durag-group.ru

DURAG UK GmbH
Lullington House, Ashby Road
Burton-on-Trent, Staffordshire
DE15 0YZ
Great Britain
Tel. +44 1283 553 481
Fax +44 1785 760 014
E-Mail: durag.uk@durag.de

DURAG Branch North
Kollaustraße 105
22453 Hamburg, Germany
Tel. +49 40 55 42 18-0
Fax +49 40 58 41 54
E-Mail: durag-nord@durag.de

DURAG Branch East
Halsbrücker Straße 34
09599 Freiberg, Germany
Tel. +49 3731 30 04-0
Fax +49 3731 30 04-22
E-Mail: durag-ost@durag.de

DURAG Branch South
Weidenweg 16
73087 Bad Boll, Germany
Tel. +49 7164 912 25-0
Fax +49 7164 912 25-50
E-Mail: durag-sued@durag.de

DURAG Branch West
An der Pönt 53a
40885 Ratingen, Germany
Tel. +49 2102 74 00-0
Fax +49 2102 74 00 28
E-Mail: durag-west@durag.de