

Your success counts

## Flow rate Indicator with very large digits



**The D-Series is a front panel mount indicator, controller and monitoring system for measurement applications in industrial environments. It is the robust alternative for your existing, not waterproof, panel meters.**

### Advantages

- Unique, robust IP66, IP67 (NEMA Type4X) panel mount front enclosure made of die cast aluminum, allowing even big jets of water and total immersion.
- Intuitive "Know one, know them all!" configuration menu, saving time, cost and aggravation.
- Resistant to harsh weather conditions: rain, snow, salty atmospheres.
- Only a few inches depth clearance for smaller, low cost panels and panel doors.

### Features

- Displays flow rate and measuring units.
- Very large 26mm (1") digits.
- Piegraph indication: ten segments.
- LED backlight option.
- Selectable on-screen engineering units.
- Ability to process all types of signals: Sine wave (coil), NAMUR, NPN/PNP pulse, Reed-switch, Active pulse signals, (0)4-20mA, 0-10V DC.
- Power requirements: Input loop powered, battery powered or 8 - 30V DC, 24V AC and 115 - 230V AC.
- Sensor supply: 1.2 / 3 / 8.2 / 12 / 24V DC.
- Auto backup of settings and running totals.
- Ambient temperature -40°C up to +80°C (-40°F up to 176°F).

## Introduction

The D010 is a local, panel mount indicator to display the actual flow rate. The measuring and time unit to be displayed are simply selected through an alfa-numerical configuration menu. No adhesive labels have to be put on the outside of the enclosure: a weather proof and user friendly solution! The configuration of K-factors or Span and number of decimals is done through software functions, without any sensitive dip-switches or trimmers.

## Configuration

All configuration settings are accessed via a simple operator menu which can be password protected. Each setting is clearly indicated with an alphanumerical description, which avoids confusing abbreviations and baffling codes. Once familiar with one D-series product, you will be able to program all models in all series without a manual. All settings are safely stored in EEPROM memory in the event of sudden power failure.

## Display

The display has very large 26mm (1") digits which can be set to show the flow rate and the measuring and time units. The display is a transfective type, which means that a high contrast reading is guaranteed, even in full sunlight. The D010 has a smart display update function incorporated. Related to the lower temperatures, the update frequency of the LCD is tuned automatically to achieve a readable display even at -40°C / -40°F.

## Power requirements

The basic power supply for the D010 is 8 - 30V DC. Several other power supplies are possible: With the 24V AC/DC and 115 - 230V AC power supplies, an 8.2 / 12 / 24V DC sensor supply is offered. For analog sensors, a 4 - 20mA input loop powered version is available. Finally we offer a long life lithium battery with a life expectancy that will last up to five years.



## Backlight

For those applications where readability during day and night is an issue, a white backlight is available. The intensity can be adjusted in the configuration menu.



All info at a glance



Easy to install



Easy to program



Know one know them all!



Reliable



User-friendly

### Overview application D010

The D010 fits in flow measurement applications where a local flow rate indication is required without re-transmission or totalizer functionality. Alternative advanced models: D012, D013, D014, D016 or the F-Series flow rate indicators.



### Signal input

The D010 accepts most pulse and analog input signals for volumetric flow or mass flow measurement. The input signal type can be selected by the user in the configuration menu without having to adjust any sensitive mechanical dip-switches, jumpers or trimmers. The analog input is available with linear and square root calculation and even as 4 - 20mA input loop powered.

Type of signal	Resistance	Low Pass filter (LP)	Max. frequency	Max. frequency Low Pass filter (LP)	Min. amplitude p-p	Remark
NPN	100kΩ pull-up	100kΩ pull-up	6kHz Threshold 1.2V	2.2kHz		Open collector
REED	1MΩ pull-up	1MΩ pull-up	1.2kHz Threshold 1.2V	120Hz		
PNP	47KΩ pull-down	100KΩ pull-down	6kHz Threshold 1.2V	1.2kHz		
NAMUR	820Ω pull-down	-	4kHz	-		External power required
COIL LO	-	-		-	90mV <sub>pp</sub>	Default sensitivity
COIL-HI					20mV <sub>pp</sub>	Sensitive for interference!
COIL-HI (Type ZF)	-	-	-	-	10mV <sub>pp</sub>	
COIL-HI (Type ZG)					5mV <sub>pp</sub>	
ACTIVE 8.2V DC	3K9Ω		10kHz Threshold 4V			External power required
ACTIVE 12V DC	4KΩ		10kHz Threshold 6V			External power required
ACTIVE 24V DC	3KΩ		10kHz Threshold 12V			External power required

## Enclosures

The D010 is supplied in a unique, robust IP66, IP67 (NEMA Type4X) class panel mount front enclosure made of die cast aluminum, based on a popular DIN sized enclosure of 144 x 72mm. The front enclosure withstands powerful water jets and even total immersion. The maximum thickness of the panel is 6mm (1/4"). The D-Series is the better alternative for your existing, not waterproof, front panel mounted indicators.

## Panel cut out

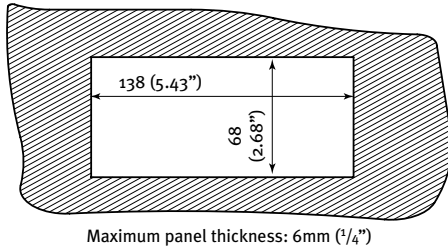

## Dimensions enclosure

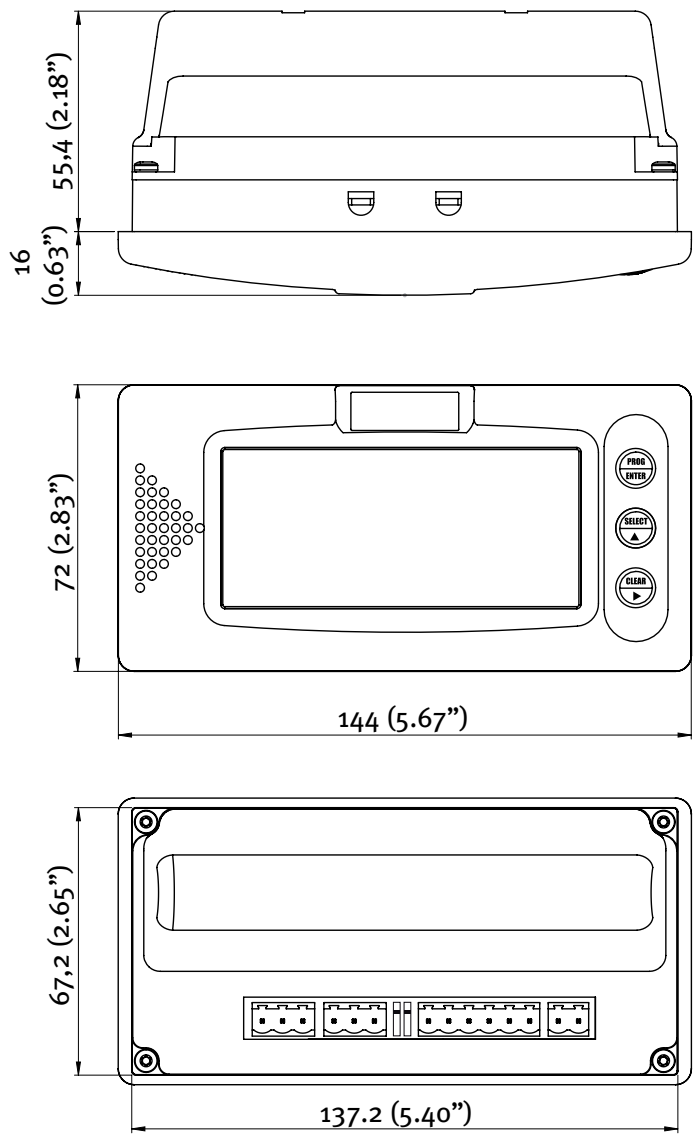

Dimensions according DIN 43700 / IEC 61554

## Terminal connections D010

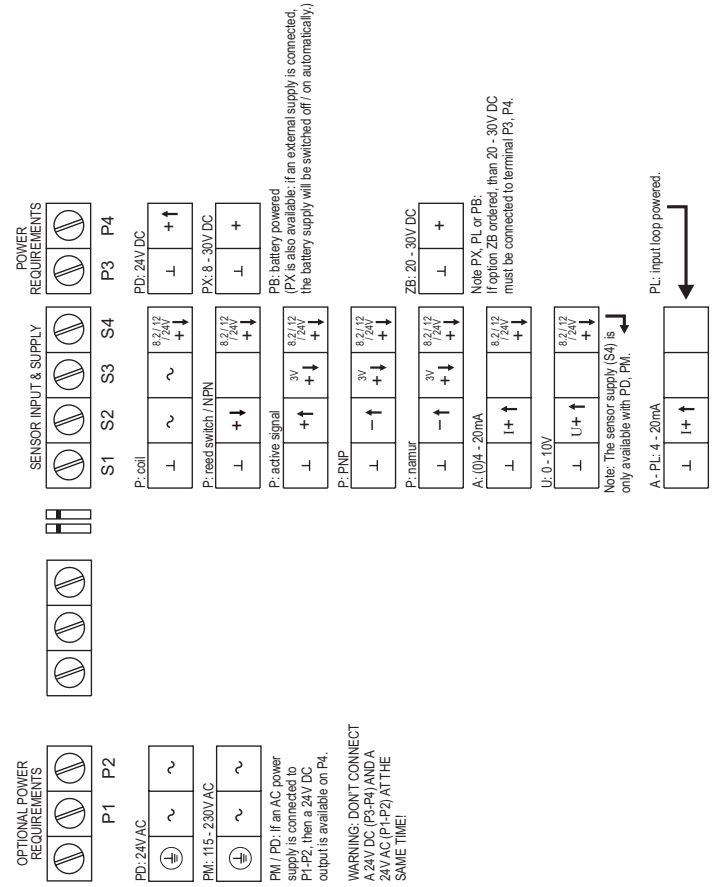

## Display example - 90 x 40mm (3.5" x 1.6")



### D010-A-PL-XX-ZB

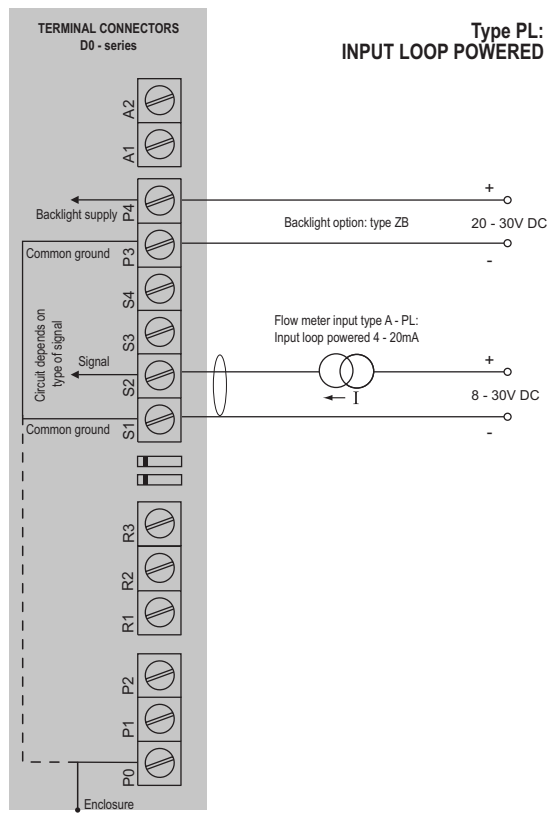

Sensor supply: sensor is externally powered.

### D010-P-PD-XX-ZB

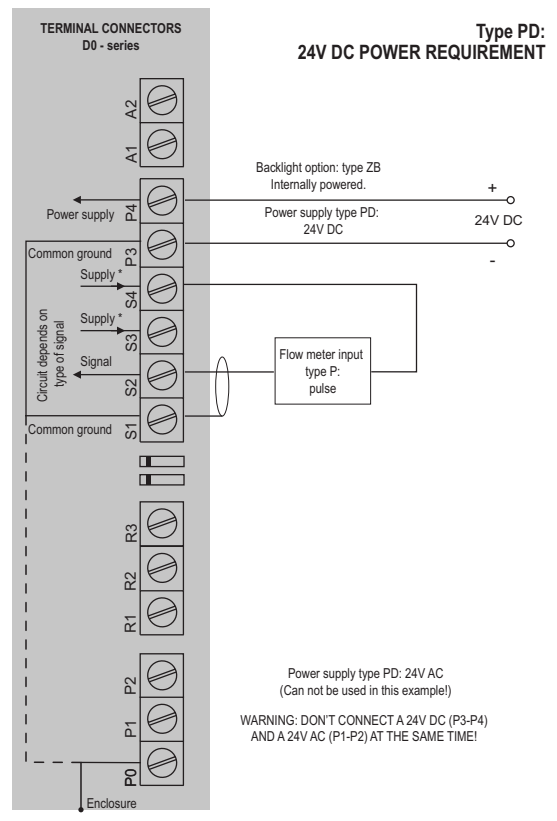

\* Sensor supply voltage for pulse flow meter type P:  
Terminal S3: 1.2 / 3V DC.  
Terminal S4: 8.2 / 12 / 24V DC.

\* Sensor supply voltage for analog flow meter type A / U:  
Terminal S4: 8.2 / 12 / 24V DC.

### D010-P-PD-XX-ZB

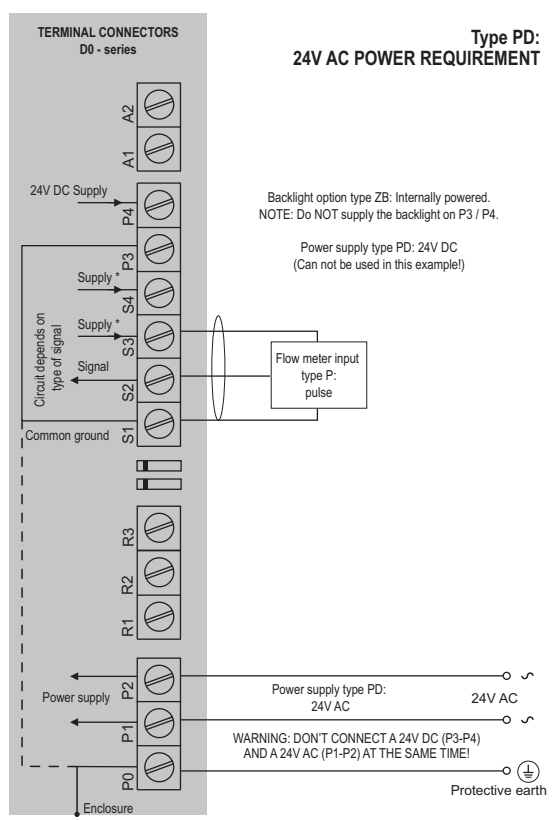

\* Sensor supply voltage for pulse flow meter type P:  
Terminal S3: 1.2 / 3V DC.  
Terminal S4: 8.2 / 12 / 24V DC.

\* Sensor supply voltage for analog flow meter type A / U:  
Terminal S4: 8.2 / 12 / 24V DC.

### D010-P-PM-XX-ZB

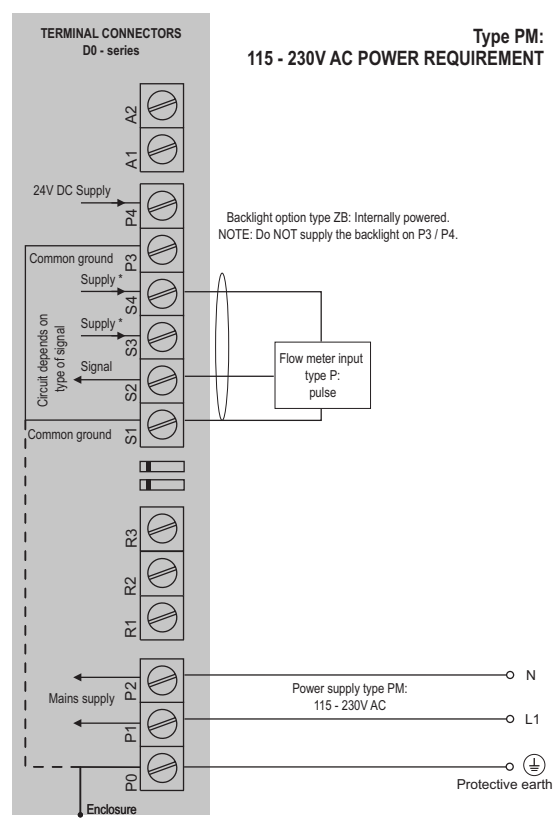

\* Sensor supply voltage for pulse flow meter type P:  
Terminal S3: 1.2 / 3V DC.  
Terminal S4: 8.2 / 12 / 24V DC.

\* Sensor supply voltage for analog flow meter type A / U:  
Terminal S4: 8.2 / 12 / 24V DC.

## Display

<b>Type</b>	High intensity reflective numeric and alphanumeric LCD, UV-resistant.
<b>Dimensions</b>	90 x 40mm (3.5" x 1.6").
<b>Digits</b>	5½ very large 26mm (1") digits. Various symbols and measuring units.
<b>Piegraph</b>	Ten segments - related to the input signal.
<b>Refresh rate</b>	User definable: fast, 1sec, 3sec, 15sec, 30sec, off.
<b>Option ZB</b>	Transflective LCD with white LED-backlight. Intensity can be adjusted in the configuration menu. Good readings in full sunlight and darkness.

## Ambient temperature

<b>Safe areas</b>	-40°C to +80°C (-40°F to +176°F).
-------------------	-----------------------------------

## Power requirements

<b>Type PB</b>	Long life Lithium battery - life-time depends upon settings and configuration - up to 5 years. (requires PL or PX)
<b>Type PD</b>	24V AC/DC ± 10%. Power consumption max. 1 Watt.
<b>Type PL</b>	Input loop powered from sensor signal 4 - 20mA (requires type A)
<b>Type PM</b>	115 - 230V AC ± 10%. Power consumption max. 1 Watt.
<b>Type PX</b>	8 - 30V DC. Power consumption max. 0.3 Watt.
<b>Type ZB</b>	20 - 30V DC. Power consumption max. 1 Watt. With type PD / PM: internally powered.

## Sensor excitation

<b>Type PB / PX</b>	3V DC for pulse signals and 1.2V DC for coil pick-up.
<b>Note PB / PX</b>	This is not a real sensor supply. Only suitable for sensors with a very low power consumption like coils (sine wave) and reed-switches.
<b>Type PD / PM</b>	for pulse signals: 1.2 / 3 / 8.2 / 12 / 24V DC For analog signals: 8.2 / 12 / 24V DC. 8.2V DC, I <sub>out</sub> max. 35mA @ 20°C. 12V DC, I <sub>out</sub> max. 50mA @ 20°C. 24V DC, I <sub>out</sub> max. 75mA @ 20°C. (this voltage can vary depending on the input supply voltage)

## Terminal connections

<b>Type</b>	Removable plug-in terminal strip. Wire max. 1.5mm <sup>2</sup> and 2.5mm <sup>2</sup>
-------------	---

## Directives & Standards

<b>EMC</b>	Directive 2014/30/EU, FCC 47 CFR part 15.
<b>Low voltage</b>	Directive 2014/35/EU
<b>RoHS</b>	Directive 2011/65/EU
<b>IP &amp; NEMA</b>	EN 60529 & NEMA 250.

## Data protection

<b>Type</b>	EEPROM backup of all settings. Backup of running totals every minute. Data retention at least 10 years.
<b>Password</b>	Configuration settings can be password protected.

## Enclosure

<b>Window</b>	Polycarbonate window.
<b>Sealing</b>	Silicone.
<b>Control keys</b>	Three industrial micro-switch keys. UV-resistant silicone keypad.

## Panel mount enclosure

<b>Dimensions</b>	144 x 72 x 71.4mm (5.67" x 2.83" x 2.81") - W x H x D according DIN 43700 / IEC 61554.
<b>Panel cut-out</b>	138 x 68mm (5.43" x 2.68") L x H.
<b>Material</b>	Die-cast aluminum front panel + GRP back enclosure.
<b>Protection</b>	IP66, IP67 (NEMA Type4X) at the front-side.
<b>Weight</b>	325 gr.
<b>Panel thickness</b>	Max. 6mm (¼").

## Signal inputs - Flowmeter

<b>Type P</b>	Coil / sine wave (HI: 20mVpp or LO: 90mVpp - sensitivity selectable), NPN/PNP, open collector, reed switch, Namur, active pulse signals 8 - 12 and 24V DC.
<b>Frequency</b>	Minimum 0Hz - maximum 6kHz for total and flow rate. Maximum frequency depends on signal type and internal low-pass filter. E.g. reed switch with low-pass filter: max. frequency 120Hz.
<b>K-Factor</b>	0.00001 - 199,999 with variable decimal pos.
<b>Low-pass filter</b>	Available for all pulse signals.
<b>Option ZF</b>	coil sensitivity 10mVpp.
<b>Option ZG</b>	coil sensitivity 5mVpp.
<b>Type A</b>	(0)4 - 20mA. Analog input signal can be scaled to any desired range within 0 - 20mA.
<b>Type U</b>	0 - 10V DC. Analog input signal can be scaled to any desired range within 0 - 10V DC.
<b>Accuracy</b>	Resolution: 16 bit. Error < 0.01mA / ± 0.05% FS. Low level cut-off programmable.
<b>Span</b>	0.00001 - 199,999 with variable decimal position.
<b>Update time</b>	Four times per second.
<b>Voltage drop</b>	Type A: max. 1V DC @ 20mA.
<b>Voltage drop</b>	Type A - PL (loop powered): max. 2.6V DC @ 20mA.
<b>Load impedance</b>	Type U: 3kΩ.
<b>Relationship</b>	Linear and square root calculation.
<b>Note A / U</b>	For signal type A and U: external power to sensor is required; e.g. type PD / PM.

## Operator functions

<b>Displayed info</b>	<ul style="list-style-type: none"> <li>• Flow rate.</li> <li>• Measuring and time units.</li> </ul>
-----------------------	---

## Flow rate

<b>Digits</b>	5½ digits.
<b>Units</b>	mL, L, m <sup>3</sup> , Gallons, kg, Ton, lb, bl, cf, RND, ft <sup>3</sup> , scf, Nm <sup>3</sup> , NI, igal - no units.
<b>Decimals</b>	0 - 1 - 2 or 3.
<b>Time units</b>	/sec - /min - /hr - /day.

		Description					
Model	<b>D010</b>	<b>Flow rate indicator with very large digits.</b>					
Input	A	(0)4 - 20mA input.	-A				
	<b>P</b>	<b>Pulse input, e.g., coil, npn, pnp, namur, reed-switch.</b>	<b>-P</b>				
	U	0 - 10V DC input.	-U				
Enclosure	<b>HB</b>	<b>Aluminum panel mount front enclosure.</b>	<b>-HB</b>				
Power	PD	24V AC / DC + sensor supply.	-PD				
	PL	Input loop powered from sensor signal 4 - 20mA - requires type A.	-PL				
	PM	115 - 230V AC + sensor supply.	-PM				
	<b>PX</b>	<b>Basic power supply 8 - 30V DC (no real sensor supply).</b>	<b>-PX</b>				
Battery	PB	Additional lithium battery (optional) - requires PL or PX .	-PB -P_				
Hazardous	<b>XX</b>	<b>Safe area only.</b>	<b>-XX</b>				
Options	ZB	Backlight.	-ZB				
	ZF	Coil input 10mVpp - requires type P.	-ZF				
	ZG	Coil input 5mVpp - requires type P.	-ZG				
	<b>ZX</b>	<b>No options.</b>	<b>-ZX</b>				
		D010	-_	-HB	-P_	-XX	-Z_

The **bold** marked text contains the standard configuration: D010-P-HB-PX-XX-ZX.