

B05

Freno Pneumatico a Pinza - Positivo

Pneumatic Caliper Brake - Air applied

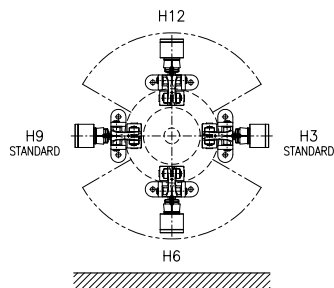

Posizione di Montaggio
Mounting Position

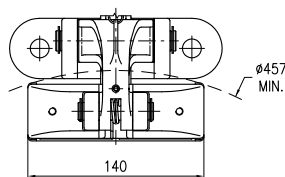

Versione Pattino Doppio
Double Pad Version

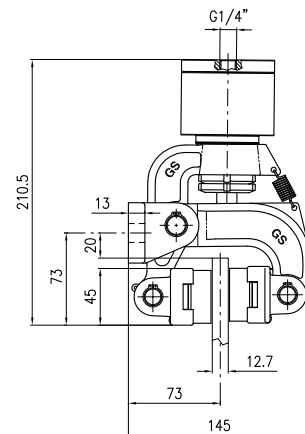
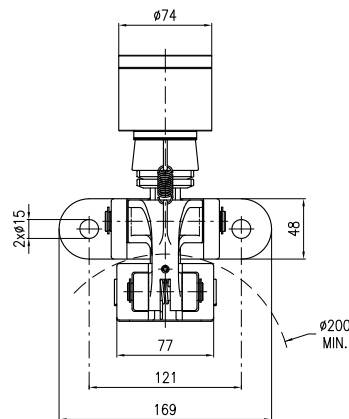

Dati Coppia / Torque data

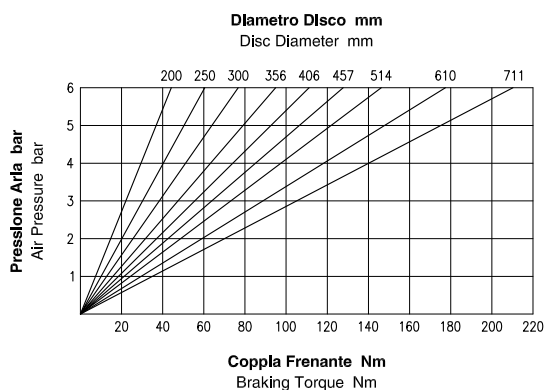

Attenzione: La coppia iniziale può essere inferiore dal 30% al 50% rispetto al valore nominale. **Warning:** The initial braking torque can be from 30% to 50% lower than the nominal value.

Dati Forza / Force data

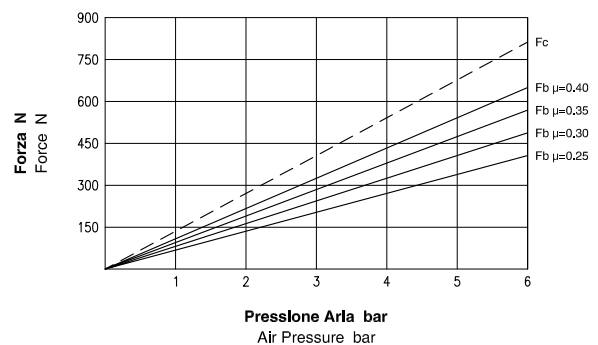

NOTA: Il grafico riporta l'andamento della forza tangenziale al variare del coefficiente di attrito. **NOTE:** The diagram shows the braking force performance with different friction coefficients.

Dati Tecnici

Coefficiente di attrito nominale $\mu = 0.40$
Forza tangenziale $F_b = F_c \cdot 2 \cdot \mu$ (N)
Forza di chiusura $F_c : 812.5$ N a 6 bar
Forza tangenziale $F_b : 650$ N a 6 bar
Raggio effettivo disco $R_e =$ Raggio disco (m) - 0.032
Coppia frenante $M_b = F_b \cdot R_e$ (Nm)
Pressione Max : 6 bar
Volume aria : 0.05 dm³
Peso versione standard : 5.3 kg
Peso versione pattino doppio : 6.1 kg
Spessore del ferodo nuovo : 16 mm
Usura Max totale : 16 mm

Technical Data

Nominal friction coefficient $\mu = 0.40$
Braking force $F_b = F_c \cdot 2 \cdot \mu$ (N)
Clamping force $F_c : 812.5$ N at 6 bar
Braking force $F_b : 650$ N at 6 bar
Effective disc radius $R_e =$ Disc radius (m) - 0.032
Braking torque $M_b = F_b \cdot R_e$ (Nm)
Max pressure : 6 bar
Air Volume : 0.05 dm³
Weight standard version : 5.3 kg
Weight double pad version : 6.1 kg
Thickness of new lining : 16 mm
Max total wear : 16 mm



Coremo Ocmea S.p.A. - T +39 02 4880697 - F +39 02 4881940

E-mail : info@coremo.it - Internet : www.coremo.com

I.T. 170401