



32 773x3B00

### UNIVERSAL COLLECTION

Single-phase overexcitation rectifiers with internal DC side disconnection through voltage detection

These rectifiers with time controlled bridge/half-wave changeover are ideal for installation in the connection boxes of brake motors, brakes and solenoids with high dynamic requirements. The internal DC side disconnection reduces connection requirements. Accessories include flying leads and mounting hardware so that installation on DIN rails is also possible. Encapsulated versions for an extended operating temperature range are available as options.

In case of the integral fast disconnection, the induction voltage induced by inductive loads is internally limited.

### Technical specifications

Principle of operation			Rectifier with time-controlled bridge-/ half-wave change-over			
Rectification			time-controlled bridge-/ half-wave change-over			
Fast switching			Intern offswitching by voltage detection			
Output voltage overexcitation / holding period $U_2$ / VDC (-8%) / (-)			$U_2 = 0,890 / 0,445 \cdot U_1$			
Disconnection voltage / OFF voltage / OFF delay $U_{offmax}$ / VAC $U_{0max}$ / V $T_{off}$ / ms			190 / 350 / 30			
Type	Rated input voltage (40 – 60 Hz) $U_1$ / VAC ( $\pm 10\%$ )	Max. output current over-excitation / holding period $I$ / ADC	Overexcitation time $T_{OE}$ / s ( $\pm 15\%$ )	Design, temperature range $\theta_{13}$ / °C	Installation	Connections
32 77303B00	220 ... 500	2,0 / 1,0	0,25	Standard, non-encapsulated -25 ... 85	screws, accessories	6 terminals max 2,5 mm
32 77333B00	220 ... 500	2,0 / 1,0	0,25	Extended, encapsulated -30 ... 100	screws, accessories	6 terminals max. 2,5 mm

### CE

#### EMC Directive 2014/30/EU:

Compliance with the following standards is confirmed:

EN 50081-2 (Emission):

EN 55011 (VDE 0875, part 11, 2011)

Group 1, Class A conducted interference

Group 1, Class B radiated interference

EN 61000-6-2 (Immunity):

EN 61000-4-3 (2011) severity level 4

EN 61000-4-4 (2013) severity level 3

EN 61000-4-5 (2015) severity level 3

#### Low Voltage Directive 2014/35/EU:

Compliance with the following standards is confirmed:

HD 625.1 S1:2009 (VDE 0110) insulation coordination

EN 60529 (2014) IP 54

external mounting

#### Maximum no. of switching operations and duty cycle

with resistive/inductive load for specific power

Reference: KENDRION series 76 431..H.. at specified max. ambient temperature.

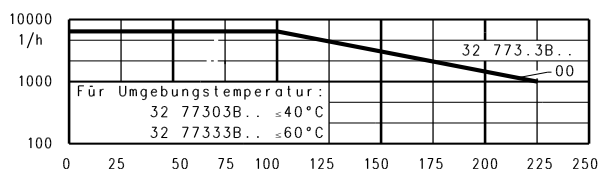

#### Machinery Directive 2006/42/EC:

These products are considered components in the sense of Machinery Directive 2006/42/EC and must not be put into service until the machinery in which they are incorporated has been declared in conformity with the provisions of the EC Directives

#### ROHS

We hereby declare that the above-mentioned products comply with the requirements of the RoHS Directive 2011/65/EU on the restriction of the usage of certain hazardous substances in electrical and electronic equipment, assigned to equipment category 11.

#### Maximum current load

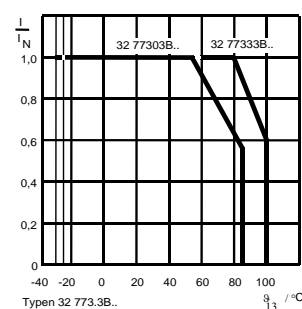

Protection  
IP 00 to EN 60529

Subject to change  
without notice.

Please observe  
ordering data!

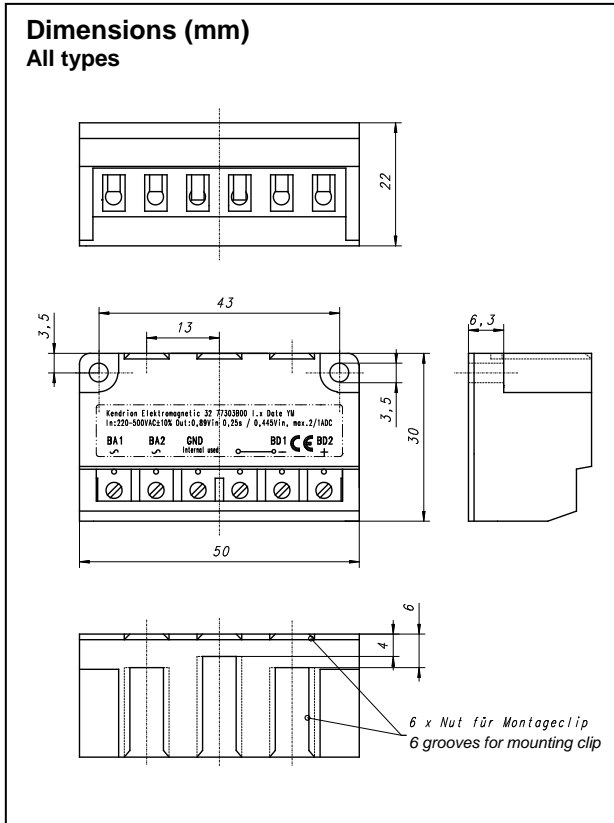

### Connection and block diagrams

All types

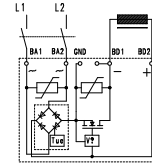

### Accessories

#### Mounting rail clip:

**32 07322A00103**

Set of mounting rails for 35mm mounting rails to EN50022

1 set per rectifier

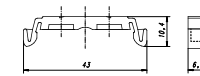

Figure similar to design

#### Adhesive pad:

**32 07322A00104**

double-sided adhesive tape for installation on smooth surfaces. Dimensions

45x20x1mm<sup>3</sup>

1 pad per rectifier

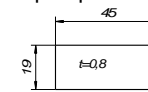

#### Flying leads:

**32 17221A03004**

Set of 2 flying leads with self-retaining fork cable lug M4, preferably for rectifier connection to motor terminal board.

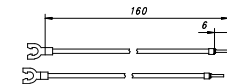

### Operation and connection

Overexcitation rectifiers with internal DC side switching are ideal for use with electromagnetic brakes of electric motors or with other electromagnetic components with high dynamic performance. They also enable the reduction of losses during holding periods. The technical specifications depend on the connected loads and on their electric and mechanical properties. When electromagnetic brakes are operated in parallel with the motor, brake engagement may be significantly delayed after disconnection due to the generator function of the motor when the specified rectifiers are used and when there are driving loads. If the rectifiers are operated at a voltage below the permitted minimum operating voltage, uncontrolled disconnection of the voltage sensor may cause malfunctions or even irreversible damage to power transmission components. All work must only be carried out by suitably qualified personnel. Make sure that no voltage is applied during connection. The specifications on the rating plate and the information provided in the circuit diagram or in the datasheet must be strictly observed. The mechanical time constants during brake release or engagement and during switching of the electromagnetic component must be taken into consideration. The maximum

switching frequency of the rectifier merely defines a limit value for the dissipated power that can be absorbed by the rectifier, taking account of the overexcitation time and its tolerance, the minimum holding time and minimum recovery time. Disconnection must take place at holding current since repeated disconnection during overexcitation may cause thermal overloading of the rectifier. Disconnection during overexcitation may affect the necessary recovery time and the subsequent overexcitation time.

#### Attention!

Rectifier operation must take place in such a way that the connected load is not overloaded and that any use of the load other than its intended use is avoided.

As a rule, the mean power must not exceed the rated power of the connected load at the rated duty cycle. The mean current load of the rectifier must not exceed the specified rated holding current at the specified ambient temperature. Check that the rectifier pinout is correct. Incorrect connection would cause irreversible damage to the rectifier.

The rectifiers are not short circuit proof. Output short circuit to ground will destroy the rectifier.

### Ordering example

overexcitation rectifier with internal fast disconnection through voltage detection

32 773  3B

0 = non-encapsulated standard version

3 = reinforced encapsulated version

0 = Toe 250 ms

0 = 220 – 500 VAC

### Kendrion (Villingen) GmbH

Wilhelm-Binder-Straße 4-6  
78048 Villingen-Schwenningen  
Germany

Phone +49 7721 877 1417

Fax +49 7721 877 1462

E-Mail [sales-ids@kendrion.com](mailto:sales-ids@kendrion.com)

[www.kendrion.com](http://www.kendrion.com)