

## Contents

	<b>Page</b>
<b>1 2D Views</b>	<b>2</b>
<b>2 Configuration settings</b>	<b>3</b>
<b>3 Attachments / Technical document</b>	<b>4</b>
<b>4 Contact information</b>	<b>5</b>

# 1 2D Views

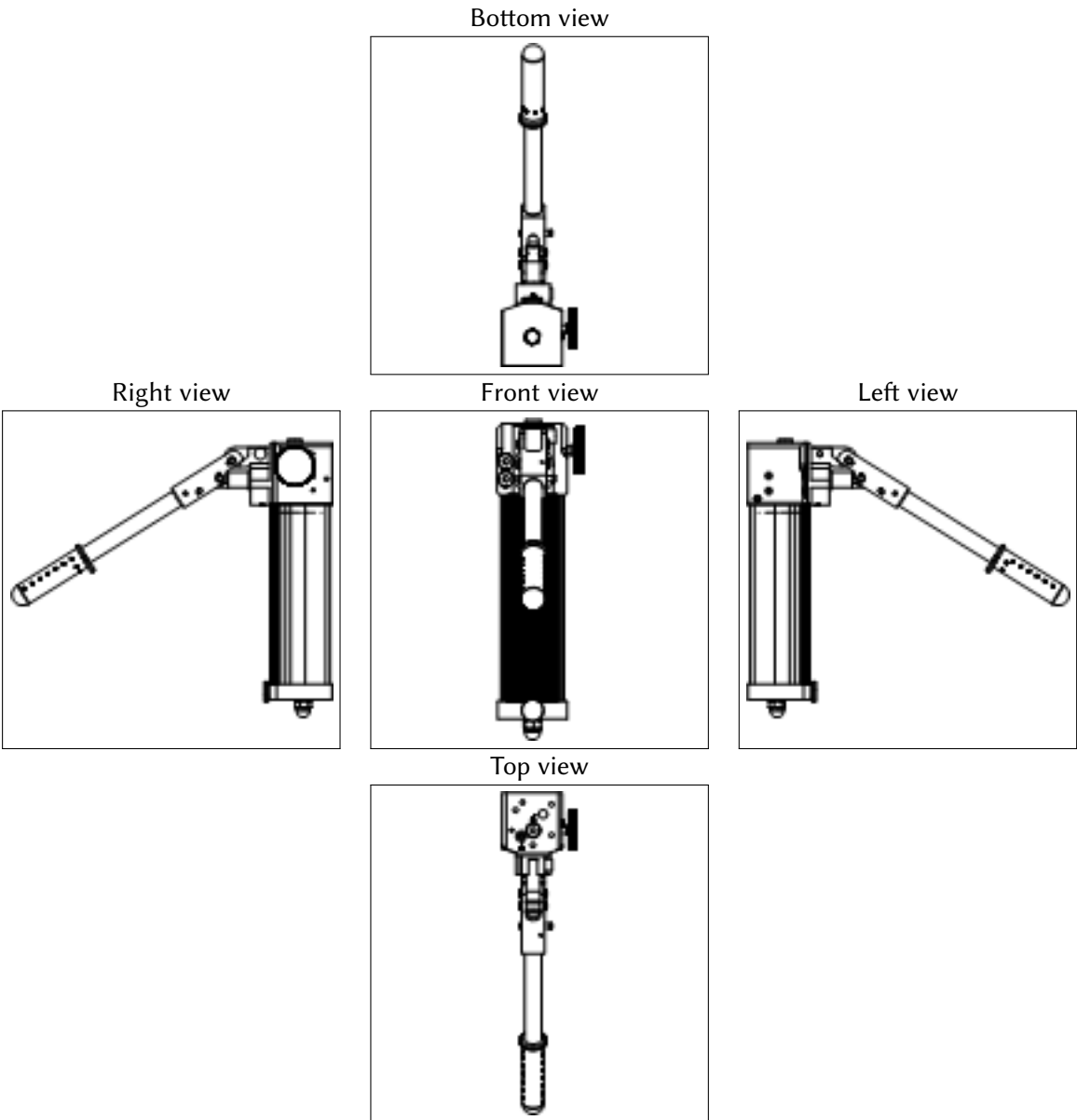







## 2 Configuration settings

Configuration	
type	LH 1/0,5-50
Order no.	841291120
Oil capacity	0,7 L
usable oil capacity	0,47 L
delivery per stroke low pressure	6 cm <sup>3</sup>
automatical switchover at Mpa	20 bar
delivery per stroke high pressure	0,8 cm <sup>3</sup>
weight (kg)	4
lever stroke 0 to	431

Bill of Materials Data	
Manufacturer	LUKAS Hydraulik
type	LH 1/0,5-50
reference	841291120
weight [ kg ]	4
Omniclass number	23.27.17.00

### 3 Attachments / Technical document

Please double click with left mouse button on a paper clip symbol to open a file. You could also save a file when you click the symbol with the right mouse button.

- dimension sheet LH 1/0,5-50 
- dimension sheet LH 2/0,9-50 
- dimension sheet LH 2/1,8-50 
- dimension sheet LH2/3,8-50 
- dimension sheet ZPH 1 
- dimension sheet ZPH 3 

## 4 Contact information

✉ LUKAS Hydraulik GmbH  
Weinstr. 39  
91058  
Erlangen  
✉ [lukas.info@idexcorp.com](mailto:lukas.info@idexcorp.com)  
@ [www.lukas.com](http://www.lukas.com)